



VHX-69C-CVL

Dakota Digital VHX Instrument Installation
For 1969 Chevrolet Chevelle, El Camino and Malibu

Your new VHX-69C-CVL kit includes:

**Universal Sender
Pack**

Installation Manuals

Control Box

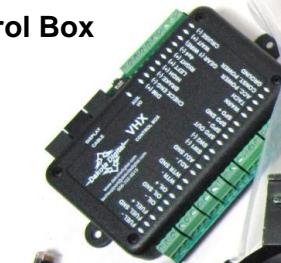

CAT5 Cables (3)

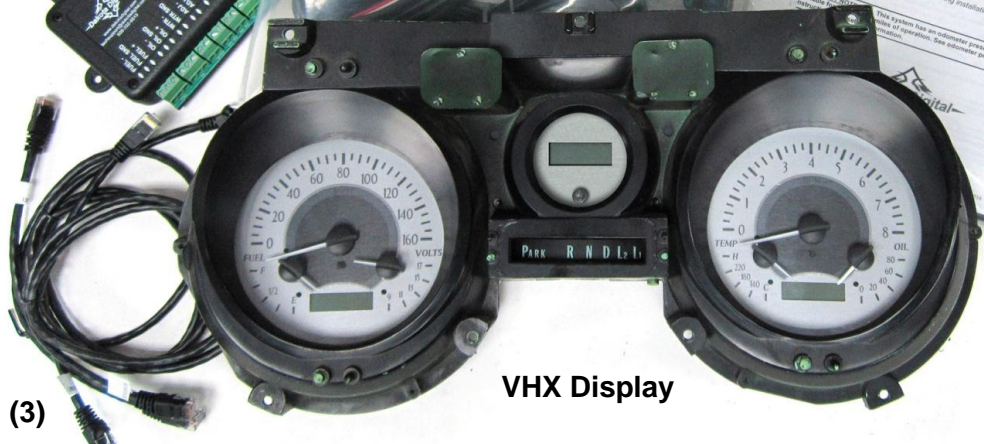

VHX Display

Installation

1. Remove the bezel from the dashboard, then, remove the instrument housing from the bezel by removing the nine screws shown below. Save these screws, as they will be used to secure the new instruments.

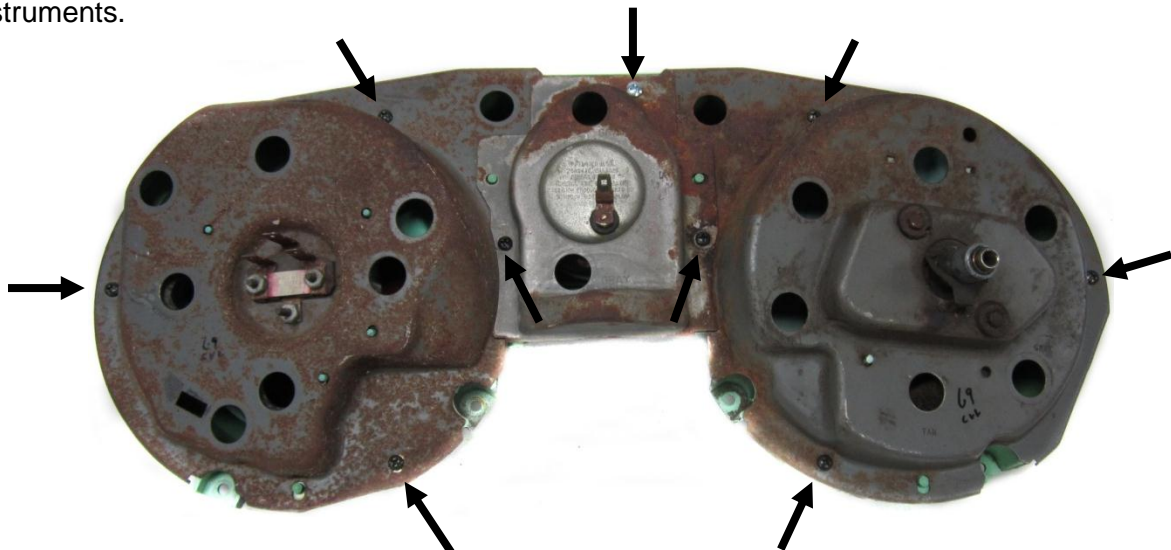

2. Remove the stock lens using a pair of side cutters or a utility knife; the original lenses will not be reused. Using a small flathead screwdriver, remove the clock adjustment screw to allow lens to be lifted off of the housing (Fig. 2b.)



Fig. 2b

3. Using the stock screws, attach the Speed and Tach instrument panels to the stock instrument housing.

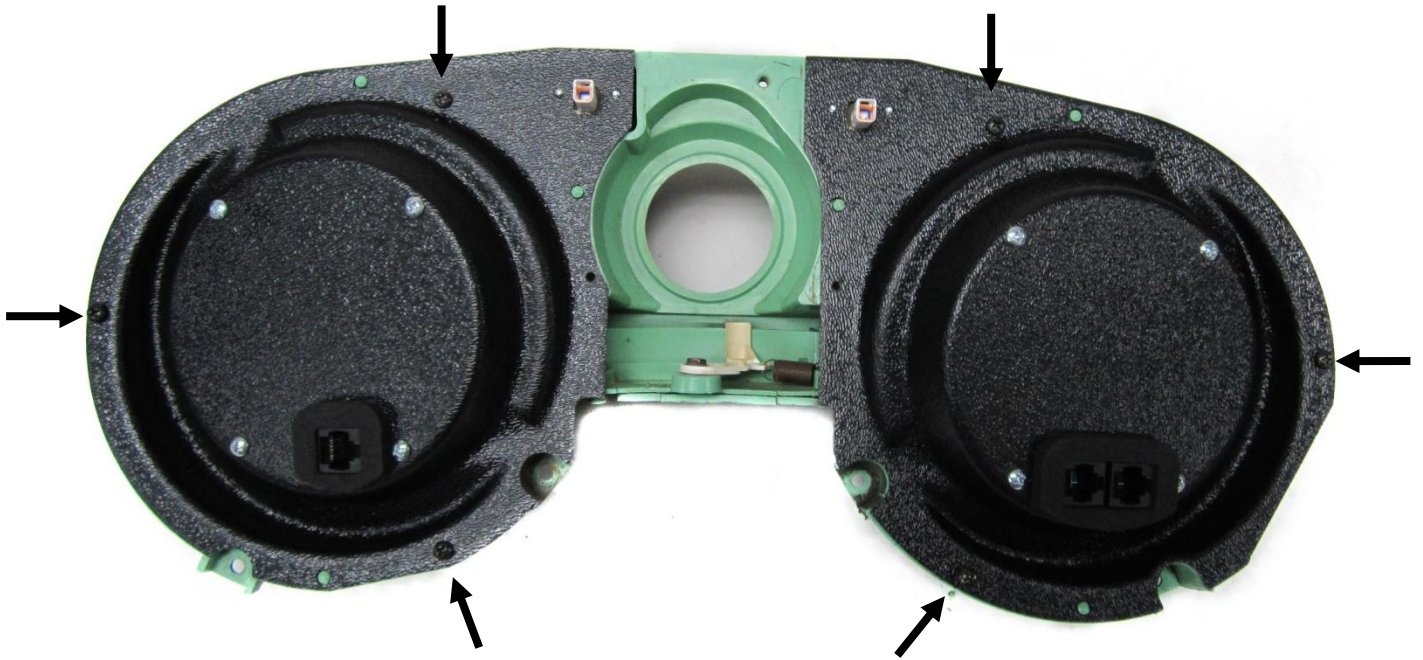

4. Install the Clock instrument panel between the Speed and Tach installed in Step 3, again using the stock screws.



5. Plug the supplied 12" cable in to the Tach port, and connect it to the left Speed port. Also plug in the supplied turn-signal harnesses if stock turn indicators are desired (see inset).

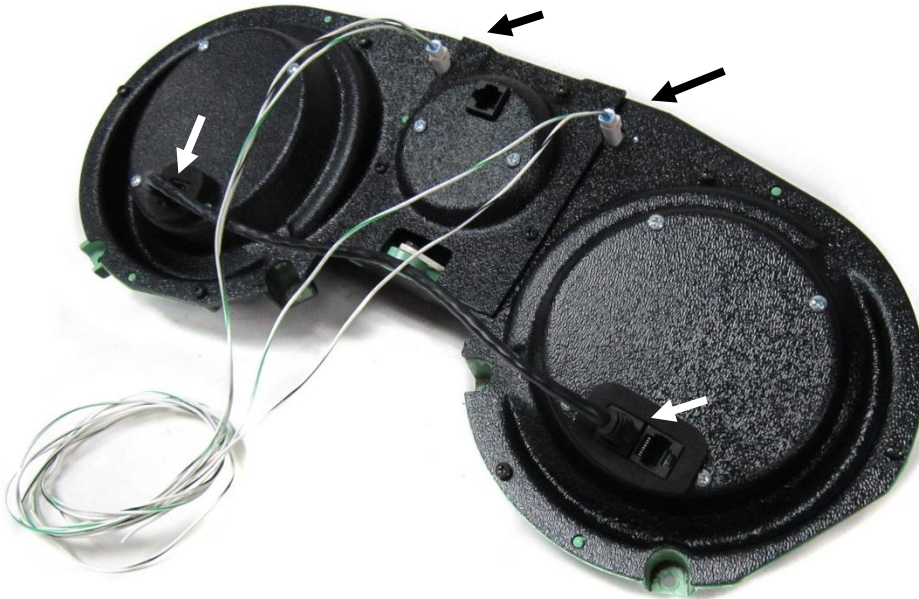

This system comes with the option to use two sets of turn signals in your dash: arrows located in the faceplate of your new VHX display, and arrows in your vehicle's stock turn signal locations. To use the new faceplate arrows, follow the wiring instructions for the turn signals found in the main VHX manual.

To optionally use the stock turn signal arrows, do not wire the turn signals to the VHX control box. Instead, use the two (2) provided two-wire harnesses. The harnesses plug directly into connectors on the back side of your new VHX system. Connect the wires from these harnesses to your turn signal circuits and ground as shown below. Doing this will light green LED bulbs, located in the original locations of your dash panel, when turn signals are active. Make sure to check left and right to verify they were wired correctly.

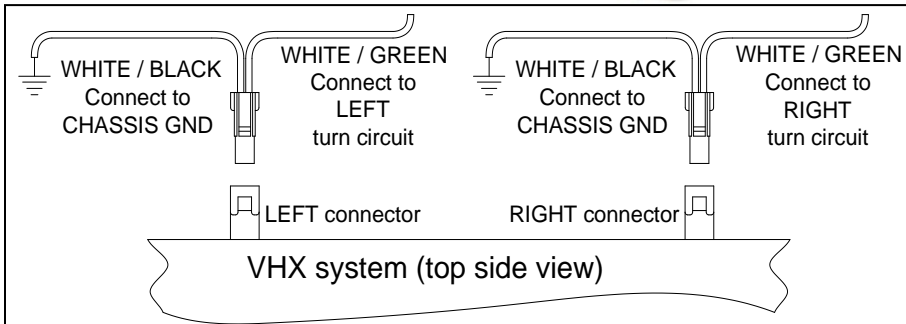

6. Connect one 36" CAT5 cable to the right Speed port. The other 36" cable connects to the clock. As the assembled cluster is installed into the dash, take care when routing these cables to the control box.

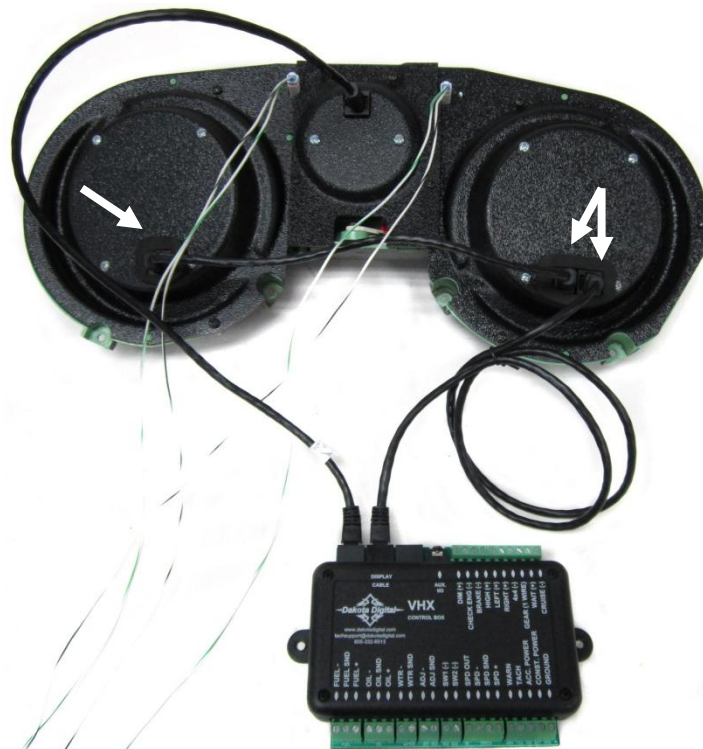

7. Install the completed cluster into the factory dash using the original screws. Shown below without harnesses for clarity.

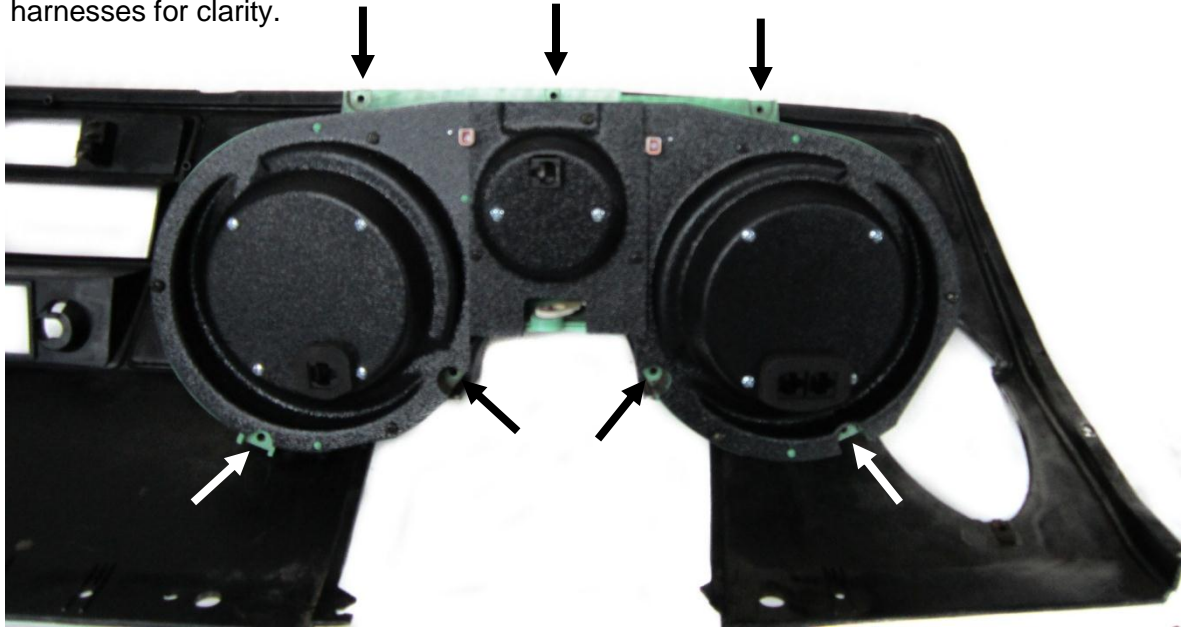

8. This instrument system allows the use of either the stock gear indicator or the GSS-2000 electronic gear indicator (sold separately) which will be displayed in the LCD message center.

Using hot glue or RTV silicone, attach the provided clear lens (shown) for the stock indicator or the included block-off lens if using the GSS-2000.



9. Re-install the dash and refer to the main manual for wiring instructions to complete the VHX installation.



4510 W. 61st St. N., Sioux Falls SD 57107
Phone: (605) 332-6513 Fax: (605) 339-4106
www.dakotadigital.com
dakotasupport@dakotadigital.com